

# GENERAL INSTRUCTIONS



## 1. INSPECTION

Check the equipment upon arrival for damage or shortages and report same to the delivering carrier.

## 2. LOCATION

Select an area for installation that is convenient for minimum plumbing runs, drain discharge, and electrical hookups. A firm level surface, concrete is preferred. Shims of a durable material may be used for leveling unit. Provide accessibility for maintaining salt storage and general maintenance of the equipment. Provide a smooth surface for the brine tank. If necessary use a sheet of 3/4" plywood as a base. Follow all local codes.

## 3. ELECTRICAL

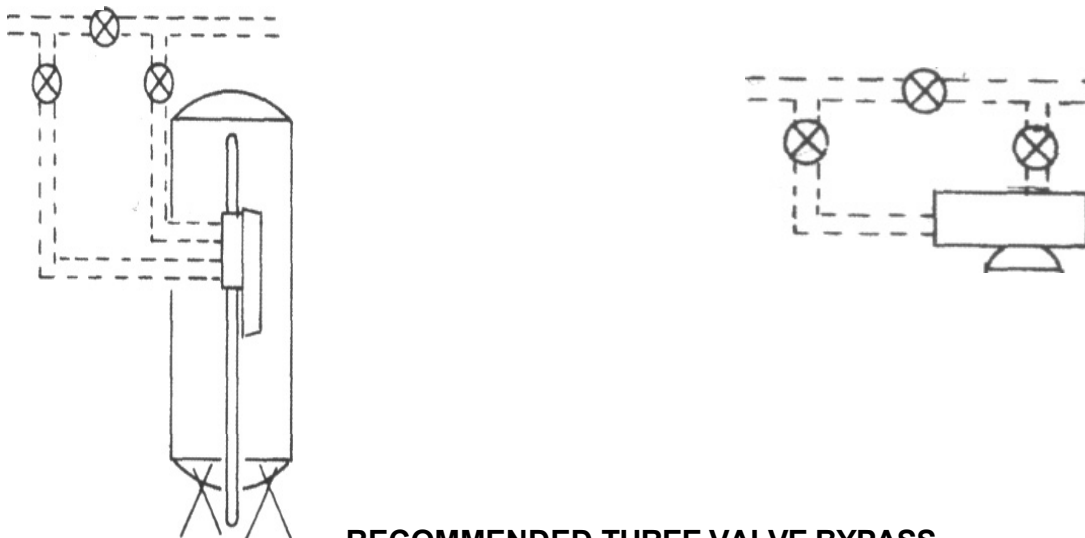
Follow all local electrical codes. Provide a 5 Amp, 120 Volt fused circuit, (2.5 Amp for 240 Volt circuit) with a shut-off switch located near the installation. Refer to the proper wiring diagram provided in this manual for the type of equipment being installed.

## 4. PLUMBING

Minimum water pressure of 25 P.S.I is required, if pressure is over 125 P.S.I, a pressure-reducing valve must be installed. Pipe size must be equal to the largest size in the existing plumbing. Drain line plumbing must be equal to the drain port provided. Increase the pipe size if the horizontal run exceeds 20 feet. When heat transfer from hot water is possible and if plumbing codes allow, install a check valve in the outlet line down stream as far as possible. Damage from hot water will void your warranty.

Brine tanks using 3/8" brine valves may be installed with the tubing provided. 1/2" and larger brine valves may be installed with rigid plumbing. Black pipe is not recommended for brine lines. Twin units, using 1/2" brine valves are supplied with a common brine valve and a brine director. If possible, the brine tank should be installed between the units. The brine tank may be located up to 20 feet from the softener. Provide stop valve in brine line.

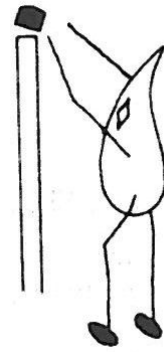
The maximum height of the brine line should not exceed 8 feet from the floor level.



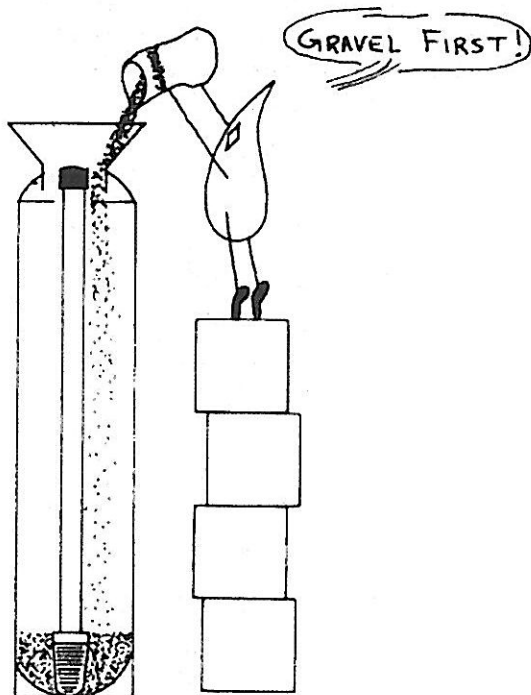
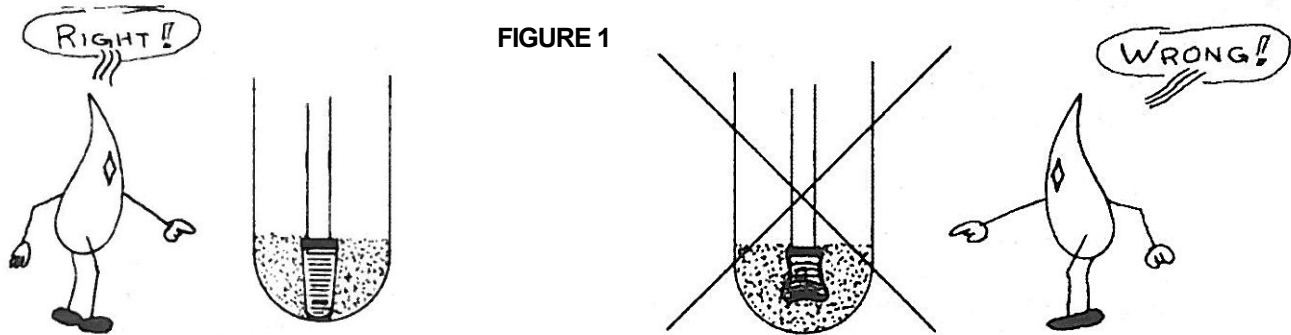
**RECOMMENDED THREE VALVE BYPASS**

# LOADING THE FIBERGLASS MINERAL TANK (Models 50 thru 450)

1. Make sure the mineral tank is empty and clean.
2. Place mineral tank at the point of installation.
3. Install the distributor tube in the mineral tank.
4. Place the plastic cap provided over the end of the distributor pipe.
5. Using the funnel (packed in the gravel carton) pour in the gravel. See O&M manual for the correct amount of gravel for your unit.



**CAUTION: Do not raise the distributor. If gravel is allowed to get under the distributor, it may cause the distributor to be crushed when the tank adapter is installed. See Figure 1.**



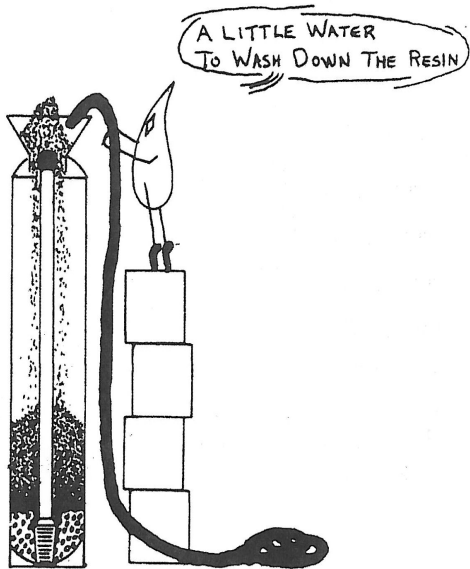


FIGURE 2

6. Wash in the amount of mineral shown in your O&M manual
7. Scoop the mineral into the funnel. With a garden hose, direct water to the side of the funnel as shown in Figure 2.

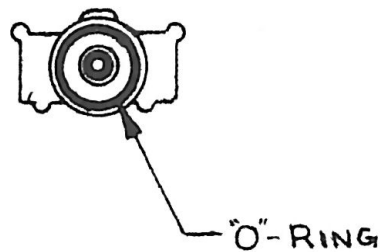
8. After loading, fill the tank with water.

## INSTALLING THE TANK ADAPTER AND VALVE

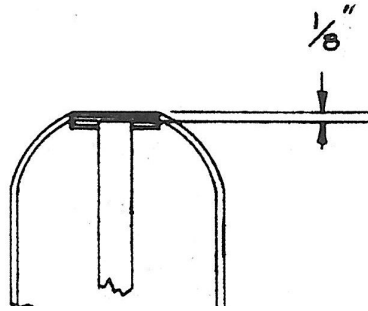
1. Remove all the resin from the top of the tank, threads and the plastic cap.
2. Remove the plastic cap.
3. Apply an "O"-Ring lubricant to the rubber tank seal O-ring and distributor O-ring, and to the top 1" of the distributor pipe.



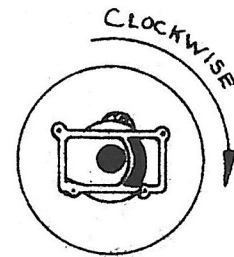
FIGURE 3



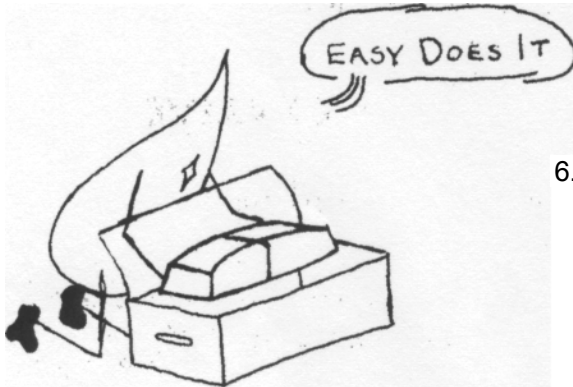
4. Install the tank adapter ring, see Figure 3.  
Make sure the distributor pipe is at least 1/8" below the top of the tank.



5. Position the tank adapter in the opening of the tank with the distributor pipe in the port provided. Thread the tank adapter into the tank and tighten until the tank adapter bottoms out on the tank. See Figure 4.

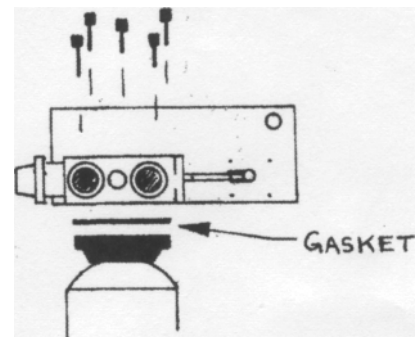


**FIGURE 4**



6. Remove the control valve from the carton.

7. Place the gasket on the tank adapter and mount the valve.
8. Install the 5 alien head screws and tighten evenly.



# LOADING STEEL TANK UNITS (Models 150 thru 1200)

**IMPORTANT:** Position tank at the point of installation. Review entire installation procedure for steel tanks before starting.

1. Remove covers from the top and side openings of mineral tank. Inspect the bottom distributor inside the unit for damage. See Figure 5. Inspect the sealing surface of both tank openings. Smooth any rough spots with a file.

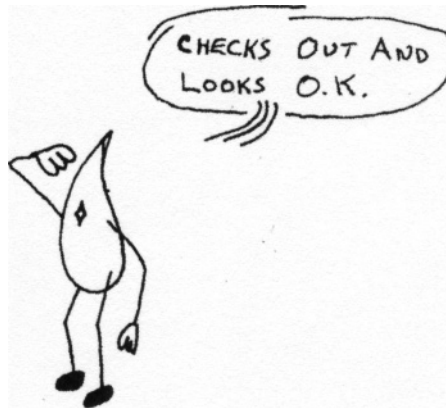
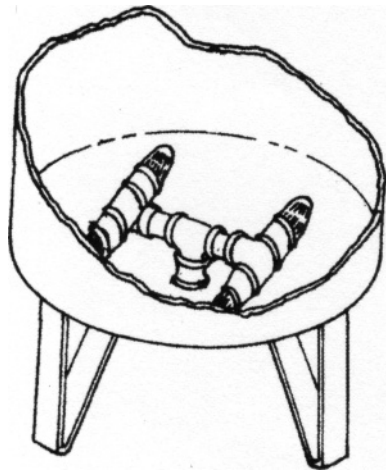
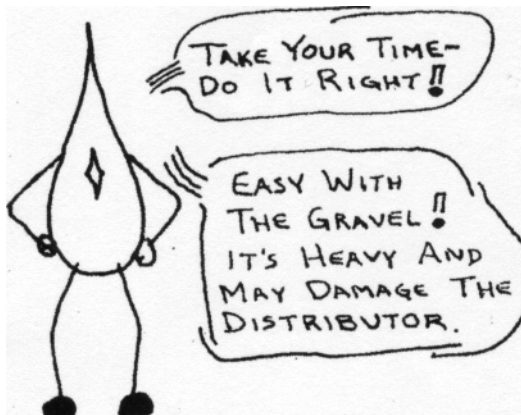
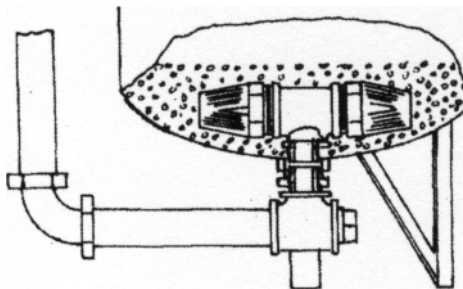


FIGURE 5

2. Pour in the required amount of gravel supplied with the unit.
3. Level gravel through side opening. The gravel should cover the distributor screens.



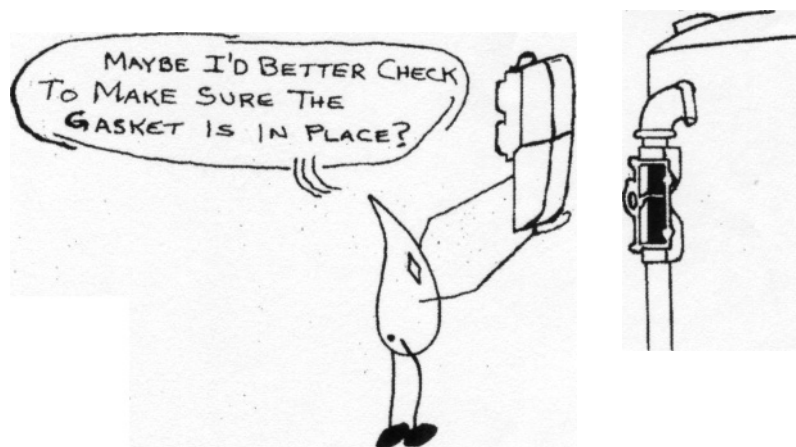


4. Install gasket and cover to the side opening in the tank. Take care to insure that all sealing surfaces are clean of dirt or gravel.

6. Replace top closure temporarily to prevent foreign materials from entering the tank during installation.

Pour in the required amount of resin through the top opening supplied with the unit. Leveling of the resin bed is not required.

## INSTALLING VALVE - STEEL TANK UNITS



1. Position the valve body on the tank adaptor with the gasket in place.
2. Install the five alien screws provided and snug up evenly.